

# MAT-WDB-CA-RM-2-0205 Series

MIMO 2x2, 2.4/5 GHz, dual-band ceiling antennas: 2/5 dBi, RP-SMA-type (male)



## Features and Benefits

- RP-SMA-type (male) connector
- Lightweight
- Easy to mount on the ceiling
- -40 to 75°C operating temperature range

## Introduction

The MAT-WDB-CA-RM-2-0205 antenna is a lightweight MIMO 2x2 dual-band ceiling antenna with a RP-SMA-type (male) connector. The antenna can be used in both the 2.4 GHz and 5 GHz frequencies and is designed to operate in temperatures from -40 to 75°C.

## Field Patterns

### Port 1 Frequency: 2.4 GHz

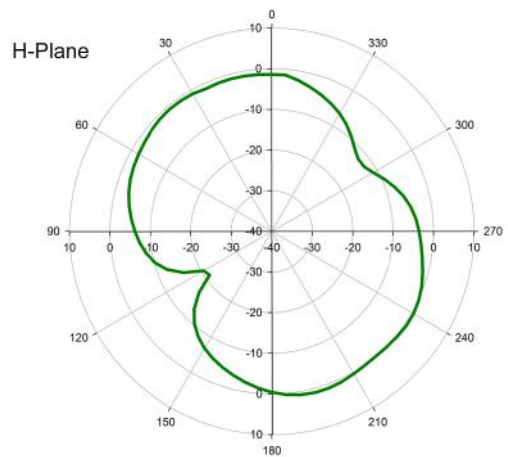
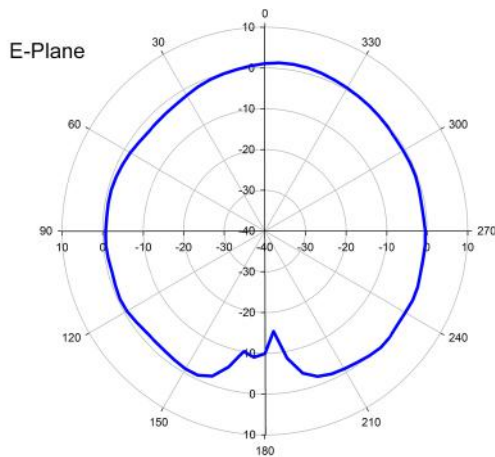

**Port 2 Frequency: 2.4 GHz**

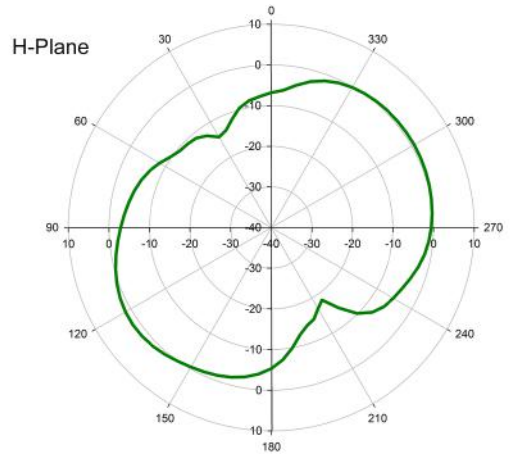
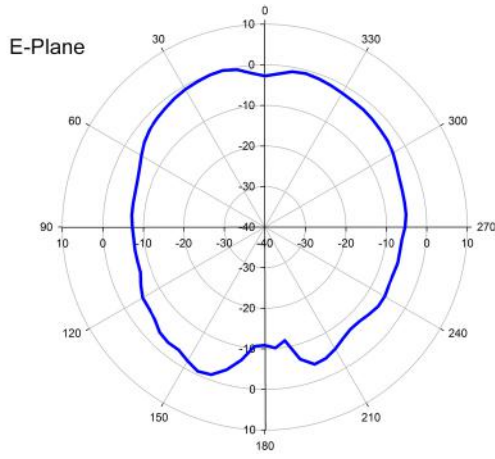

**Port 1 Frequency: 5 GHz**

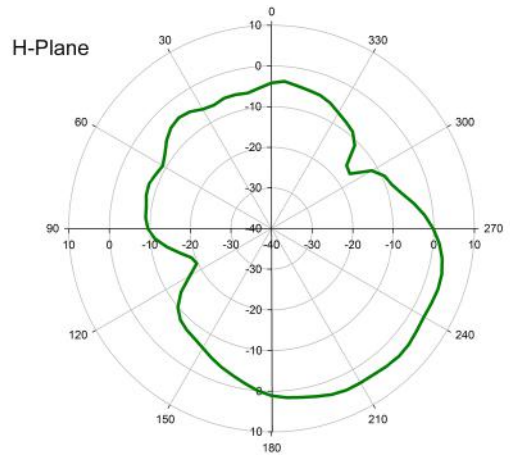
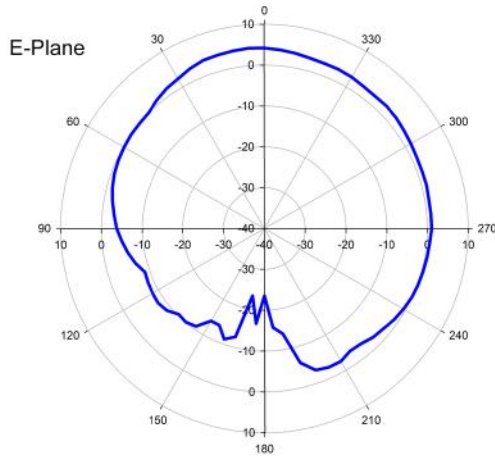

**Port 2 Frequency: 5 GHz**

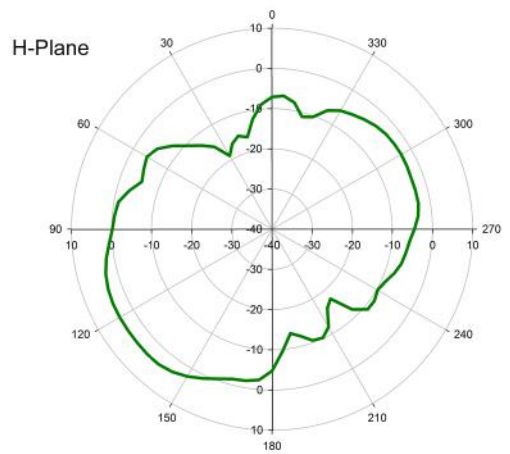
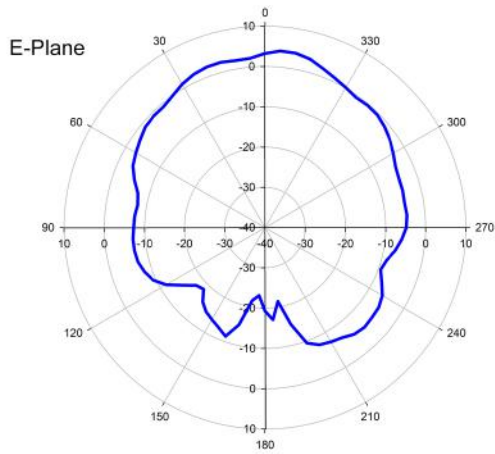

**Specifications**

**Antenna Characteristics**

Frequency	2.4 to 2.5, 4.9 to 5.9 GHz
Antenna Type	MIMO 2x2, Omni-directional
Typical Antenna Gain	2/5 dBi
Connector	RP-SMA (male)
Impedance	50 ohms

Polarization	Linear
HPBW/Horizontal	360°
V.S.W.R.	2:1 max.
Power Handling	10 W (max.)

#### Physical Characteristics

Weight	115 g (0.25 lb)
Height	37 mm (1.46 in)
Diameter	210.9 mm (8.3 in)
Radome Color	White
Radome Material	ABS
Installation	Ceiling mount
Cable	RG-178
Cable Length	250 mm (9.84 in)

#### Environmental Limits

Operating Temperature	-40 to 75°C (-40 to 167°F)
Storage Temperature (package included)	-40 to 75°C (-40 to 167°F)
Ambient Relative Humidity	5 to 95% (30°C, non-condensing)

#### Warranty

Warranty Period	1 year
Details	See <a href="http://www.moxa.com/warranty">www.moxa.com/warranty</a>

## Dimensions

Unit: mm

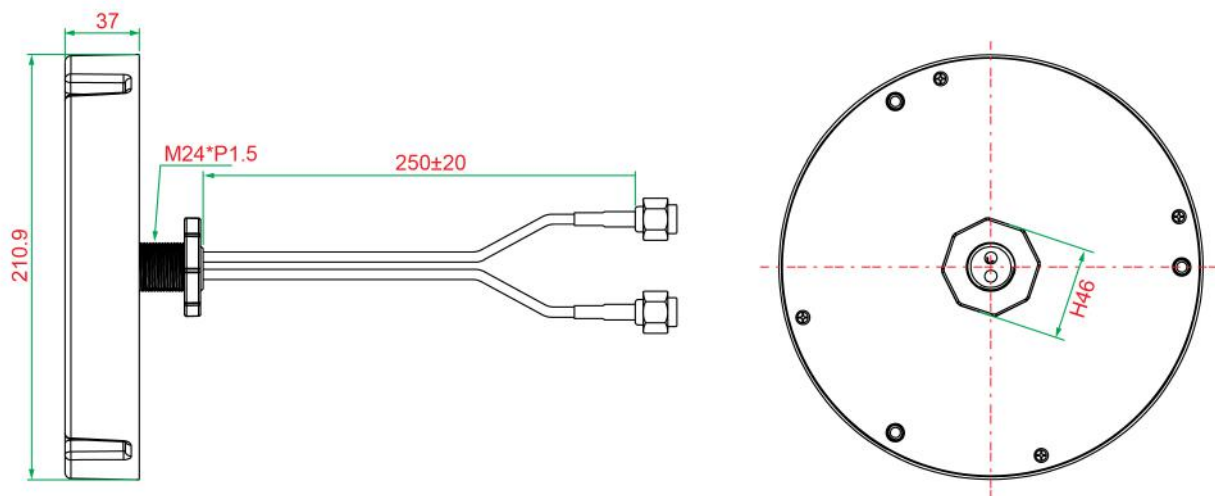

## Ordering Information

Model Name	Frequency	Antenna Type	Antenna Gain	Connector
MAT-WDB-CA-RM-2-0205	2.4 to 2.5, 4.9 to 5.9 GHz	MIMO 2x2, Omni-directional	2/5 dBi	RP-SMA (male)

© Moxa Inc. All rights reserved. Updated Nov 12, 2018.

This document and any portion thereof may not be reproduced or used in any manner whatsoever without the express written permission of Moxa Inc. Product specifications subject to change without notice. Visit our website for the most up-to-date product information.